



Pulley Guard - 505862

Install the Major Accessory and Pulley

1. Place the short end of the mounting base holes, and insert - but don't tighten - the setscrews.

NOTE

If the Major Accessory has eccentric (offset in the middle) mounting tubes, position the upper part (the long end) of the tubes away for pulley end of the stand.

If you are installing a Strip Sander, you must replace the mounting tubes with the eccentric tubes (5137779) supplied in Pulley and Belt Package #521767.

If you are installing a Bandsaw with straight mounting tubes, you must either cut 1 1/2" off the long end of the tubes, or purchase eccentric tubes.

2. Mount the Major Accessory on its tubes so the drive shaft is located over the opening in the top panel of the power stand.
3. Tighten the setscrews in both the mounting base and the Major Accessory.
4. Locate the proper sized tool pulley, refer to the Chart of Pulleys, Belt and Speeds.
5. Slide the proper pulley on the Major Accessory's power shaft, making sure to align the pulley setscrew directly over the flat area on the shaft.
6. For now, tighten the pulley setscrew slightly. You will securely tighten the setscrew after you align the pulleys.

Install the Motor Pulley

7. Locate the proper sized motor pulley by referring to the Chart of Pulleys, Belts, and Speeds. Also take note of the motor pulley-to-tool pulley and shaft-to-pulley relationships.
8. Insert the motor shaft key in the slot on the motor shaft. Then align the key 'way' located on the pulley with the key on the motor shaft. When aligned, slide the pulley onto the shaft.
9. Slightly tighten the pulley setscrew.

Align the Motor Pulley and the Tool Pulley

NOTE

You should follow the procedures in this section every time you wish to change speeds which require resetting the tool pulley-to-motor pulley relationship.

10. Decide which tool speed you want to achieve by referring to the Chart of Pulleys, Belts, and Speeds.
11. Use a straightedge to align the pulley steps you want to use, making sure they are in line with each other, see Figure 1. You can adjust the pulleys by sliding them on their shafts.

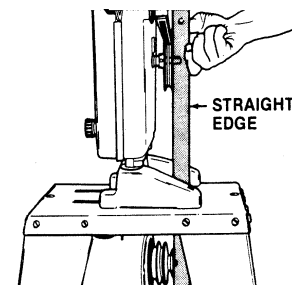

Figure 1 - Use a straightedge to align the pulleys.

CHART OF PULLEYS, BELTS, AND SPEEDS

Shopsmith Accessory Pulley Kit Item No.	20" Scroll Saw		11" Bandsaw	4" Jointer	6" Beltsander	Strip Sander
	N/A	N/A				
Motor Pulley Shopsmith Item No.	2 1/2"-1 1/2"/3-1 1/2" 1/4"		2 1/2"/3" 51389001	4.5" 51386803	2 1/2"/3" 51389001	2 1/2"/3 1/4" 505653
Tool Pulley Shopsmith Item No.	1-3/4" 1/2"-1/4" 1/2"-3/4" 3-1/4"		4.5" 51386803	2" 505651	3" 517913	3.5" 51386801
Standard V-Belt Shopsmith Item No.	30" 51385401	26" 51385407	40" 51385403	30" 51385401	38" 51385404	35" 51385406
	Standard Set-Up Wood & Plastic	Optional Set-Up Plastic & Metals				

12. When the pulleys are aligned, securely tighten the setscrews on both pulleys.
16. When the V-belt has proper tension, tighten the setscrews, thus locking the mounting tubes.

Install the Pulley Guard Brackets

13. Refer to the instructions supplied for the pulley guard assembly. Follow those instructions to install the brackets which hold the pulley guard.

NOTE

For the Jointer and Strip Sander, you will need to remove the tool from the power stand before you can install the pulley guard brackets.

Install the V-Belt

14. Place the V-belt over both pulleys.



BEFORE you set the belt tension and operate your Major Accessory on its power stand, be certain that the motor is level and not tilted. Each of the four motor mounting screws must equally support the motor.

15. To set proper belt tension, loosen the tube-locking setscrews on the Major Accessory, then raise or lower the tool until the V-belt has approximately 1/2" deflection on each side of it.

NOTE

You may find that some speed settings will require loosening the mounting base's setscrews, and raising the tubes in the mounting base, in order to set the proper belt tension.

NOTE

If the V-belt 'whips' during operation, the belt's tension is too loose. To correct this situation, repeat steps 15 and 16.

Install the Pulley Guard

1. After you have completed installing the V-belt and adjusting the tension on the belt, place washer (5) on the end of the carriage bolt (4).
2. Place the Pulley Guard (1) over the carriage bolt and place washer (5) on end of the carriage bolt.
3. Tighten lock knob (2) on end of the carriage bolt (4).
4. Refer to your Power Stand Owner's Manual (845006) for Operations.

Pulley Guard

Introduction

This pulley guard is used when a Shopsmith Major Accessory is mounted on the Shopsmith Major Accessory Power Stand (513963). The guard is easily mounted and quickly removed to change belts on step pulleys and to permit easy mounting of different Major Accessories.

NOTE

Because the bracket (3) is use so many ways, the slot may seem too wide and one end or the other may need to be cut-off. Sorry for any inconvenience this may cause.

Tools Required

- Flathead screwdriver
- 3/16" Allen wrench
- 7/16" wrench
- Hacksaw with 24 TPI
(Bandsaw and Jointer only.)

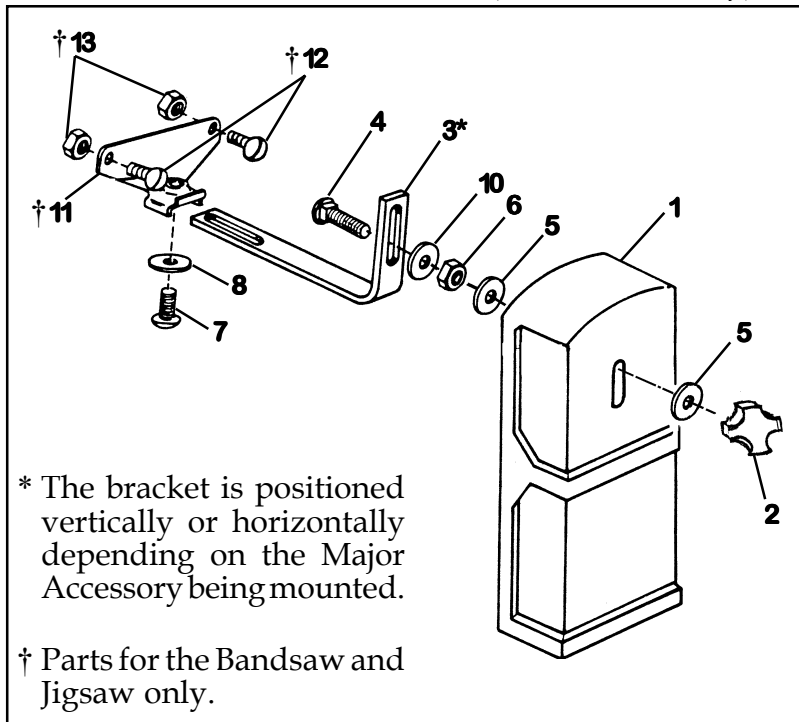

* The bracket is positioned vertically or horizontally depending on the Major Accessory being mounted.

† Parts for the Bandsaw and Jigsaw only.

Parts Explosion

Parts List

Ref No.	Part No.	Item Description	Qty
--	505862	Pulley Guard (incl. 1-13)	
1	513422	.. Pulley Guard	1
--	513713	.. Hardware Pack (Incl. 2-13)	1
2	521768	.. Lock Knob	1
3	504084	.. Bracket	1
4	126315	.. Carriage Bolt, 1/4"-20 x 1"	1
5	120392	.. Flat Washer, 1/4"	2
6	124818	.. Hex Nut, 1/4"-20	1
7	513809	.. Socket Head Cap Screw,	1
		5/16"-18	
8	120393	.. Flat Washer, 5/16"	1
9	51368606	.. Allen wrench 1/4" (not shown)	1
10	517454	.. Steel Washer	1
● <i>Additional Parts for Bandsaw</i>			
11	504083	.. Adapter	1
12	436732	.. Pan Head Screw,	2
		#10-24 x 1/2"	
13	274737	.. Hex Nut, #10-24	2

Instructions

Follow these instructions for mounting the Pulley Guard on your Major Accessory:

Bandsaw

1. Remove the bandsaw cover.
2. Insert two hex nuts (13) into the hex recesses located slightly below the center of the lower wheel, inside the bandsaw frame.
3. Mount the adapter (11) to the outside of the bandsaw cover by inserting the two machine screws (12) through the adapter (11) and then into the hex nuts (13). Tighten the screws securely.
4. Reinstall the bandsaw cover.

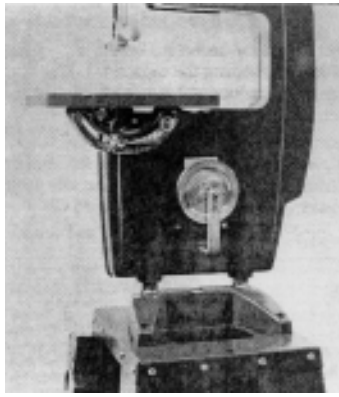
**Bandsaw**

5. Use a hacksaw to cut 7/8" from the short end of the bracket (3).
6. Mount the short end of the bracket (3) to the adapter (10) using the cap screw (7) and washer (8). Slide the bracket toward the bandsaw until the end of the bracket hits the bandsaw frame. Tighten the cap screw securely.
7. Insert the carriage bolt (4) (threaded end pointing away from the bandsaw) through the slot in the long end of the bracket (3). Add the washer (10), hex nut (6). Position the bolt near the center of the pulley. Tighten the hex nut securely, wedge a small slot screwdriver behind the bolt head to help tighten the hex nut. Do not install the pulley guard (1) yet.
8. Refer to Installing V-belt section of this Owner's Manual.

Beltsander

1. Mount the long end of the bracket under the Beltsander between the eccentric mounting tubes using the cap screw (7) and washer (8). Slide the bracket all the way back toward the Beltsander. Tighten the cap screw securely.
2. Insert the carriage bolt (4) (threaded end pointing away from the Beltsander) through the slot in the short end of the

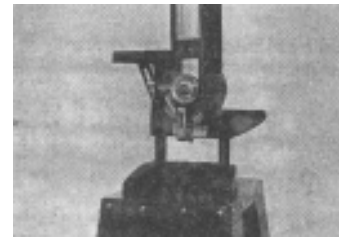
**Beltsander**

bracket (3). Add the washer (10) and hex nut (6). Position the bolt at the top of the slot. Tighten the hex nut securely, wedge a small slot screwdriver behind the bolt head to help tighten the nut. Do not install the pulley guard (1) yet.

3. Refer to Installing V-belt section of this Owner's Manual.

Strip Sander

NOTE

Make sure that you have replaced the mounting tubes with the eccentric mounting tubes (5137779) provided in your Belt and Pulley Package (521767).

1. Mount the long end of the bracket (3) on the mounting base using the cap screw (7) and washer (8). Before firmly tightening the capscrew (7), position the bracket 3/4" beyond the edge of the mounting base, on the other side of the stand's V-belt hole. Tighten the cap screw securely.

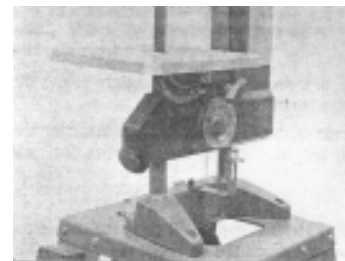
**Strip Sander**

2. Insert the carriage bolt (4) through the slot in the short end of the bracket (3). Make sure the threaded end points away from the Strip Sander. Add the washer (10) and hex nut (6). Position the bolt at the top of the slot. Tighten the hex nut securely, wedge a small slot screwdriver

behind the bolt head to help tighten the nut. Do not install the pulley guard (1) yet.

3. Refer to Installing V-belt section of this Owner's Manual.

Jointer

1. Use a hacksaw to cut 1-1/8" from the long end of the bracket (3).
2. Loosen the two setscrews in the mounting base and remove the Jointer and eccentric mounting tubes from the mounting base.
3. Mount the long end of the bracket (3) to the mounting base using a cap screw and washer (8). Position the bracket so it overhangs the mounting base approximately 1/4". Tighten the cap screw securely.
4. Mount the Jointer in the mounting base and securely tighten the two setscrews to lock the eccentric mounting tubes in the mounting base.
5. Insert the carriage bolt (4) (threaded end pointing away from the Jointer) through the slot in the short end of the bracket (3). Add the washer (10) and hex nut (6). Position the bolt near the center of the pulley. Tighten the hex nut securely, wedge a small slot screwdriver behind the bolt head to help tighten the nut. Do not install the pulley guard (1) yet.
6. Refer to Installing V-belt section of this Owner's Manual.

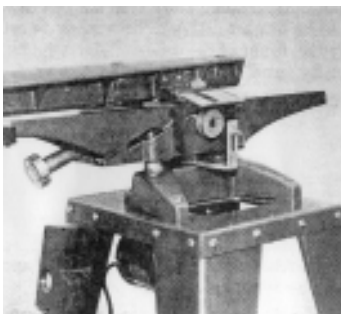

Jointer

Scroll Saw

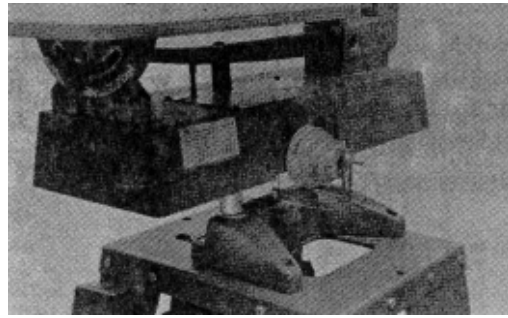

1. Mount the long end of the bracket (3) on the mounting base using the cap screw (7) and washer (8). Slide the bracket as far away from the scroll saw as possible. Tighten cap screw securely.
2. Insert the carriage bolt (4) (threaded end pointing away from the scroll saw) through the slot in the short end of the bracket (3). Add the washer (5) and hex nut (6). Position the bolt near the center of the pulley. Tighten the hex nut securely. Do not install the pulley guard (1) yet.
3. Refer to Installing V-belt section of this Owner's Manual.

Follow all the Safety, Alignment and Operations instructions in your Instruction Sheets and Owners Manual. If you lost or misplaced your manual, contact Shopsmith Customer Service. Do not operate the machine without reading and thoroughly understanding the manual.

NOTE

If you have any additional questions, please call our Customer Service Department Toll-Free at 1-800-762-7555. Or visit our website www.shopsmith.com.

