

SHOPSMITH adjustments



Part I. ADJUSTMENTS FOR QUALITY AND ACCURACY OF WORK

Shopsmith, like all precision machinery, can be adjusted to insure completely accurate work. Whether your Shopsmith is new or has been in use for some time, it is advisable that you give it regular check-ups and make any necessary adjustments. While Shopsmith is factory adjusted, it is possible during shipping and handling for certain components to become misaligned. Extensive or unusually heavy use could also cause adjustments to change. This factory recommended guide was prepared for your Shopsmith check-ups. To insure the utmost accuracy, it is desirable, in this section, to follow the exact sequence as described.

1. Saw Table

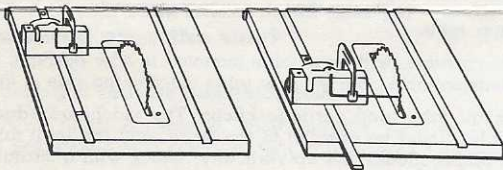

✓ Are the miter gauge slots parallel to the saw blade?

CHECK the miter gauge slot in the saw table to the saw blade for parallelism as follows:

- Lower the table over the saw, in the usual manner, until the saw table is about $\frac{1}{8}$ " from the top of the headstock. Lock all the knobs and levers on the headstock, carriage and table.
- Place the miter gauge in the right hand table slot and set the miter gauge at its 90° position (approximately).
- Clamp a piece of metal or Allen wrench to the face of the miter gauge so that the long end protrudes to the left of the gauge—approximately $\frac{1}{2}$ " (in line with a cutting tooth of the saw blade). If available use the miter gauge stop rod. It is excellent for this operation.
- Adjust the blade by advancing the quill until one cutting tooth nearest the front of the saw table just touches the piece you have clamped to the miter gauge. Lock the quill securely and mark the saw tooth.
- Rotate the saw blade (opposite to normal rotation) towards the rear of the table and move the miter gauge towards rear of table and check the same tooth.
- Make a trial cut and check the work with a square.

ADJUST as follows:

- Partially loosen the four hex head cap screws that secure the saw table to the trunnion and table bracket.
- Rotate the saw table by tapping it into proper alignment.
- Carefully tighten the four hex head cap screws.

CAUTION: The action of the screw head as it is tightened tends to shift the table out of alignment; therefore, tighten as follows:

- Tighten front left screw until snug.
- Tighten rear right screw until snug.
- Tighten rear left screw until snug.
- Tighten front right screw until snug.
- Repeat procedure until all screws are tight.

2. Saw Table (90° , 45° and Vertical Positions)

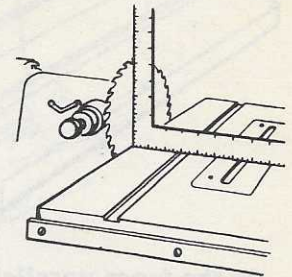

✓ Is the saw table square to the saw blade?

CHECK the perpendicularity (right angle— 90°) of saw table to saw blade.

- Set the angle of the table so that trunnion reads "0".
- Lower saw table to its lowest position.
- Lock carriage, headstock, and table rods.
- Set left edge of saw table adjacent to saw blade. (Do not use a hollow ground blade.)
- With a square, check the angle between the blade and the table top; it should be exactly 90° . Make certain that the square rests against the face of the blade between two of the saw teeth.
- Make a trial cut and check the work with a square.

ADJUST as follows:

- Loosen the trunnion nut with the trunnion wrench. Depress the trunnion stop lever and adjust the tilt of the saw table until the table is square with the blade. Then retighten the trunnion nut with the trunnion wrench.
- Loosen the small cap screw and nut which secure the trunnion indicator to the tie bar and tightly press the indicator into the depression in the trunnion. While holding the indicator tightly in the depression, tighten the trunnion cap screw and nut which secure the indicator.

3. Miter Gauge

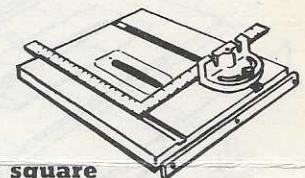

✓ Is the miter gauge square to the saw blade?

CHECK the miter gauge to the saw table slots.

- Place the miter gauge in one of the table slots.
- Loosen the miter gauge knob.
- Swing the miter gauge castings to either side of the 90° position and let it finally come to rest at 90° .
- Tighten the miter gauge knob and check the angle between the face of the miter gauge and the other saw table slot by placing a carpenter's square against one side of the slot and the face of the miter gauge.

ADJUST as follows:

- Set the miter gauge casting exactly square with the saw table slot, as described above.
- Tighten the miter gauge knob.
- Loosen indicator screw and tap the small indicator casting until the pointer reads exactly 90° on the miter gauge; retighten indicator screw.
- Make several trial cuts and check the work with a square.

4. Fence

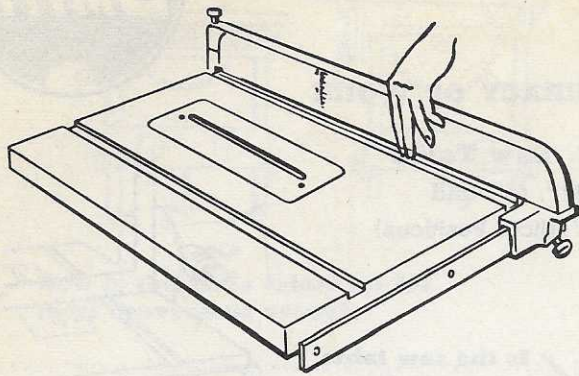

✓ Is the fence parallel to the saw blade?

CHECK the fence to the saw table slot.

a Place the fence on the table in the usual manner. **Always tighten the front lock knob first.**

b Check one side of the fence to the edge of one of the table miter gauge slots.

ADJUST as follows:

a Place the fence on the saw table and tighten the front lock knob on the fence base. Do not tighten the back lock knob.

b Loosen the two cap screws on the under side of the fence base.

c Adjust the fence until it is exactly parallel to the table slot. Lock the back lock knob.

d Tighten the two cap screws.

5. Table Insert

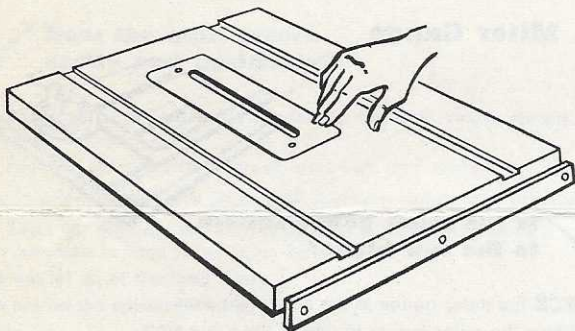

✓ Is the table insert flush with the table top?

CHECK by feel and sight.

ADJUST as follows:

a Loosen the two flat head socket screws which secure the insert to the table top.

b Tilt the table until it is perpendicular to the Shopsmith ways.

c Holding the insert in position against the table top, adjust the four socket set screws on the under side, as necessary, to bring the table insert flush with the top of the table.

d Tighten the two flat head socket set screws which secure the insert to the table top.

6. Extension Table

Saw table butted against fence

Vertical alignment of fence bars

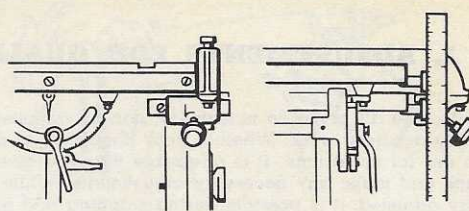

✓ Is the extension table parallel to the saw blade and saw table?

CHECK the extension table, with fence mounted on extension table to the machined edge of the saw table.

a Mount the extension table on the tailstock in the usual manner.

b Mount the fence on the extension table as far to the right as possible.

c Adjust saw table so that it is approximately 1" higher than extension table.

d Slide carriage, with saw table mounted in saw position, towards the extension table until the saw table touches the side of the fence.

e Lock all table and carriage knobs. The machined edge of the saw table should be parallel to the fence, and the front table bars of both tables should line up vertically; check with a straight edge.

ADJUST as follows:

a Partially loosen the two hex head cap screws on the under side of the extension table bracket and tap the extension table until the extension table front bar is in alignment with the saw table front bar and the edge of the table lines up (parallel) with the fence.

b Hold the fence against the edge of the saw table.

c Carefully tighten the two hex head cap screws.

7. Floating Center

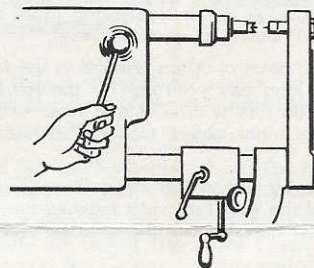

✓ Is the tailstock cup center "on center" with the spindle?

CHECK the drive center to the cup center.

a Set Shopsmith up as a lathe and assemble the drive center on the spindle tip. Mount the tailstock on the Shopsmith in the usual manner. Place the cup center in the floating center on the tailstock.

b Slide the headstock towards the tailstock as far as it will go.

c Advance the quill by use of the feed lever until the points of the two centers meet.

ADJUST as follows:

a Partially loosen the large hex nut on the rear of the tailstock.

b Tap the floating center assembly until the points are in alignment.

c Tighten the large hex nut and floating center by using two wrenches, one to hold the floating center on the front side of the tailstock and one to tighten the nut.

Part II. GENERAL MAINTENANCE, ASSEMBLY AND MISCELLANEOUS ADJUSTMENTS

1. Carriage Positioning Stud

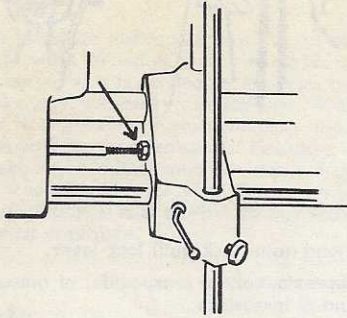

✓ **Does carriage positioning stud properly locate the saw table so it can be lowered over the saw?**

CHECK setting of carriage positioning stud.

a With saw blade on spindle, slide carriage towards headstock until the positioning stud contacts front of headstock casting.

b Lower the saw table over saw blade. The saw blade should fall directly in the center of the insert slot.

ADJUST as follows:

a Loosen hex nut that secures carriage positioning stud to carriage and adjust stud so that carriage will stop at correct position. Tighten hex nut.

2. Pulleys and Motor

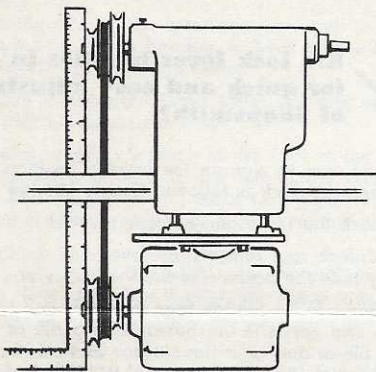

✓ **Are the pulleys lined up with each other?**

CHECK pulley alignment with a carpenter's square or straight edge.

a Place the square or straight edge against the faces of the pulleys. To aid this operation, the short leg of the square may rest on the bench top. The edge of the square should touch the rim of the two pulleys at both top and bottom of each pulley.

ADJUST as follows:

a To make the outer face of the motor pulley vertical (upper to lower rim)—Loosen the motor bracket rod set screws in the headstock (one at each end of the headstock). Raise or lower one end of the motor as necessary to bring both rims in contact with the square, at the same time adjusting the right-left location of the pulley as described below.

b To bring both pulleys into vertical alignment—Loosen the four hex head screws and nuts that secure the motor to the motor bracket casting. Slide the motor until the pulleys line up, as described above.

3. Belt Tension

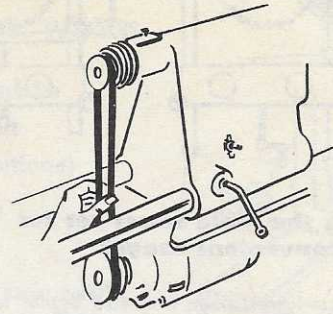

✓ **Is the belt too tight—too loose?**

Correct belt tension is important for long bearing and belt life.

CHECK the belt tension:

a By placing forefinger and thumb on the outside of the belt at a point between the tubular ways. A normal pressure between the fingers should bring the belt together until the gap between is approximately one inch.

b **Note:** It is better to have the belt a little loose than too tight. The belt should be **just tight enough so that it will not rub on the tubular ways.**

ADJUST as follows:

a Loosen the two socket set screws which secure the motor base plate rods in the headstock until the motor hangs by the belt.

b With a wood block, or similar device, lift the motor until the belt tension is correct, as described above.

c Lock the two socket set screws in the headstock.

d Always make certain motor is parallel to top of bench.

4. Saw Splitter

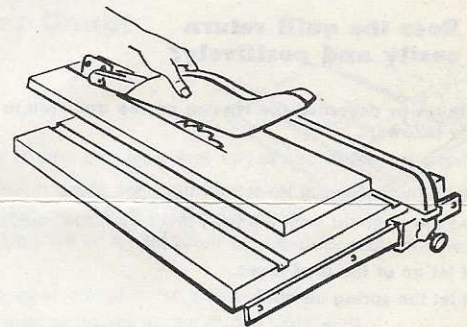

✓ **How is saw splitter lined up with saw blade?**

Here is an easy method of accurately adjusting the saw splitter.

a Rip a board **without** the saw splitter in place until the board protrudes beyond the rear of the table about three inches. The board should not be ripped all the way through.

b Turn the switch off and let the saw blade stop.

c Leave the board in place and assemble the saw splitter into the split portion of the board which protrudes over the table.

d Secure the saw splitter to the rear of the table with the small round head machine screw and lock washer. Slide the board back and make certain that it does not bind between saw blade and splitter.

5. Table Raiser

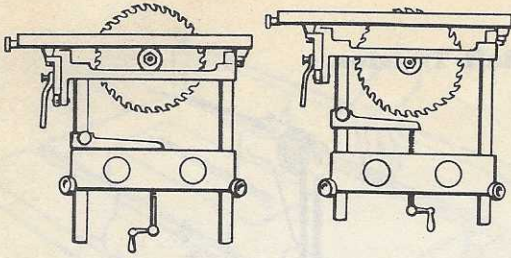

✓ How is the table raiser set for most convenient usage?

- Lower table to lowest point over saw blade; lock carriage lock knobs.
- Lower table raiser screw and arm to lowest position. Tighten table raiser arm knob and loosen carriage lock knobs.
- Full range of elevation and depression is now available in movement of the saw table.

NOTE: Never operate your machine with the point of the table raiser screw lower than the top of the carriage. Sawdust and dirt may collect in the top of the tapped hole and cause the table raiser screw to become inoperative.

6. Quill Return Spring

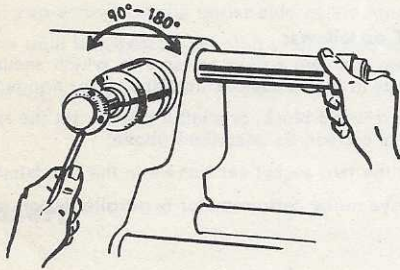

✓ Does the quill return easily and positively?

To increase or decrease the tension on the quill return spring, proceed as follows:

- Remove the depth gauge rod lock nuts and square washer.
- Unlock the quill lock lever and unscrew about three revolutions.
- Feed the quill out with the feed lever until the pinion gear inside the headstock disengages from the quill.
Do not let go of the feed lever.
Do not let the spring unwind.
- Continue to turn the feed lever shaft approximately 90° to 180° forward for more tension, backward for less. Hold this position.
- With free hand, feed quill back into headstock until the pinion gear is felt to engage the quill rack teeth. (Make certain that the pinion engages the quill teeth before releasing the feed lever handle.)
- Remove the feed lever handle from the feed lever knob.
- With one hand on the pulley and one hand on the tip of the spindle, rotate spindle tip until quill snaps back into head. This is necessary in order that the splines on the rear end of the spindle engage the splines in the drive sleeve. Should the quill still not return fully, remove the wedge lock and lever and reassemble same. The wedge may have turned sideways, thereby blocking the quill.

7. Greasing Spindle Splines



- Fully extend quill; lock quill lock lever.
- Insert approximately a teaspoonful of grease in spline opening at pulley end of headstock.
- Work quill back and forth, using finger tip to help the grease work into the spline section.

8. Lock Levers—Quill, Headstock and Carriage

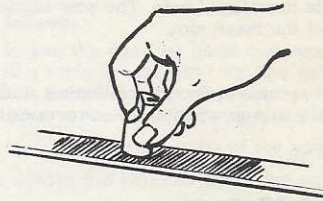

✓ Are lock lever handles in position for quick and easy adjustment of Shopsmith?

If you care to change the locking position of one of the three lock levers, proceed as follows: (**Single Wedge Machine**)

- Lock the lever and note its position.
- Unlock and remove the lever and wedge from its casting (carefully note the position of the wedge as you unscrew the lock lever).
- Remove the wedge from the lever and lightly sand the large end (the end opposite the bevel). Use a file or still sanding disc. Place the file or disc on a flat surface and rub wedge against same. $\frac{1}{8}$ " removal of metal is equal to 180° change of position of the lock lever handle.
- Replace the wedge and lever with the beveled portion of the wedge facing the tube upon which it locks.

NOTE: A small amount of grease or heavy oil on the lock lever thread will aid the tightening of the lock lever.

(**Double Wedge Machine**)

- Lock the lever and note its position.
- Unscrew lock lever handle far enough to disengage lever from the hex nut in rear wedge.
- Carefully remove nut and wedge from rear.
- Rotate nut in hex hole of wedge and replace assembly. Rotating the nut from one flat to the next will change the locking position of the handle 60°.