



# Scroll Saw Table

515815

Ref. Part No. No.	Description	Qty.
-- 515992	Table Assembly	1
1 515815	Table	1
2 516061	Insert assembly	1
3 515954	Phillips head screw	4
-- 516029	Phillips head screwdriver, #0	1

Exploded View

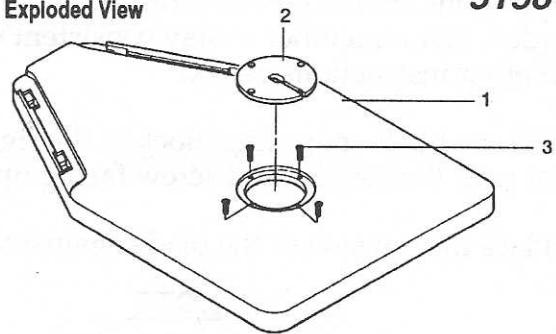

## INTRODUCTION

This Scroll Saw Table is a newer design than the one shown in the Scroll Saw Owners Manual (PL-5156). The new table has two blade mounting fixtures—one for right handed people and one for left handed people. Additionally, the new Scroll Saw Table's insert has been redesigned. This sheet tells you how to level it with the surrounding table surface and how to use the blade mounting fixtures which are now built into the table. Please follow the instructions below.

## LEVEL THE TABLE INSERT

1. Make sure that the four screws (3) are installed in the table (1).
2. Place the table insert (2) in the table (1) insert opening as shown in Fig.1. Slide the two spring clips (located on the rear underside of the table insert) under the bottom rear edge of the insert opening.
3. Snap the insert in place by pushing it toward the rear of the table and down into the table insert opening. See Fig.2.
4. Feel the edge of the table insert where it meets the table:

-If it is **level** with the table around the insert's perimeter, then no further adjustment is required.

### NOTE

To adjust the rear screw (farthest from the table's front edge), tilt the table to a 45 degree angle in either direction. This will give your screwdriver the clearance it needs to make the adjustment.

-If the insert is **below** the table surface, then use the Phillips screwdriver provided (see Fig.3) through one of the insert's four small diameter holes, and raise the screws (3) by turning counterclockwise. (See NOTE above.)

-If the insert is **above** the table surface, then lower the screws (3) by turning clockwise. (See NOTE above.)

Adjust all four screws so the insert is fully supported and flush with the table surface, as in Fig.3. This adjustment should only need to be done once, but you should periodically check to see that the table insert is flush with the scroll saw table.

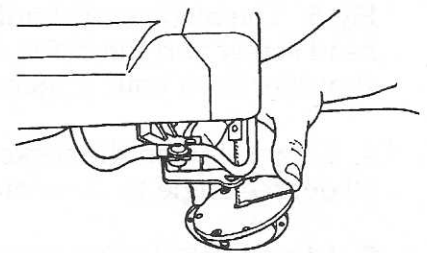

Fig.1

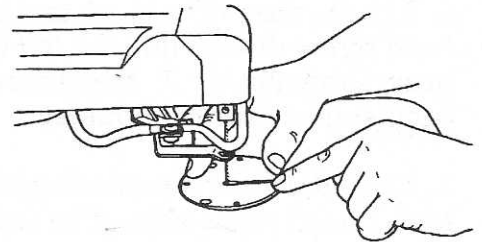

Fig.2

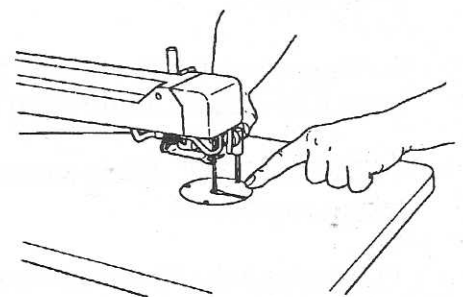

Fig.3

## INSTALLING BLADES IN THE MOUNTING BLOCKS

The following instructions take the place of "Installing Blades," Steps 1 through 5, on pages 8 and 9 of the Scroll Saw Owners Manual (PL-5156).

Illustrations shown here are for right handed people. If you are left handed, just remember to stay consistent with the blade direction and other instructions below.

1. Place a blade mounting block in the right (short) mounting block inset with the socket head screw facing upward as in Fig.4.

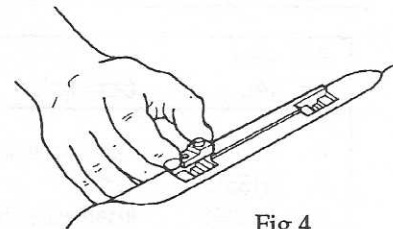

Fig.4

2. Place the flat side of the blade against the fixture's shoulder.

### NOTE

If you are mounting a blade less than .030" wide, the blade must be **CENTERED** (top to bottom) in the clamping surface of the mounting block assembly. The blade must **NOT** rest on the shoulder of the blade mounting block.

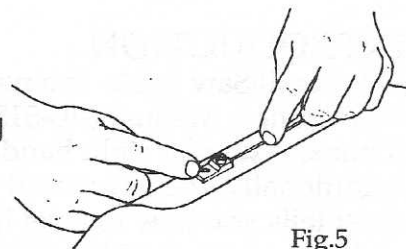

Fig.5

3. Insert the end of the blade into the mounting block, as in Fig.5. The blade end should touch the mounting block's socket head screw and the blade should also be held against the fixture's shoulder with your fingers.

4. Finger tighten the socket head screw. The blade should remain at a 90 degree angle to the mounting block.

5. With a 5/32" Allen wrench, tighten the socket head screw in the mounting block. See Fig.6.

6. Lift the mounting block and blade assembly and place it "socket head screw down" into the left (longer) side of the mounting block inset, shown in Fig.7. Make sure to keep the flat side of the blade against the fixture's shoulder.

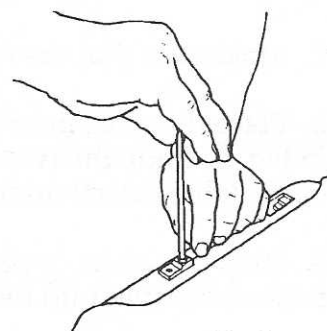

Fig.6

7. Place the second mounting block in the right (short) mounting block inset. The socket head screw should be facing upward.

8. Insert the end of the blade into the mounting block. As before, the blade end should touch the mounting block's socket head screw and the blade should also be against the fixture's shoulder with your fingers.

9. Finger tighten the socket head screw as before. The blade should be at a 90 degree angle from the mounting block.

10. With a 5/32" Allen wrench, tighten the socket head screw in the mounting block.

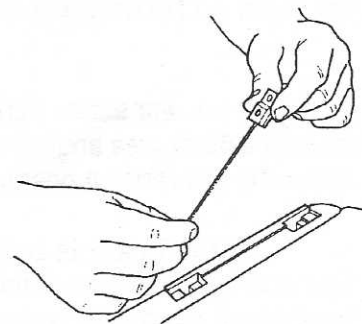

Fig.7

11. Remove the blade and mounting block assembly from the mounting block fixture.

**FOR FURTHER INSTRUCTIONS, RETURN TO THE SCROLL SAW MANUAL, PAGE 9, STEP 6.**